



Product: [RSWT 5L-949](#)

M12 Power Single-Ended Cordset: Male, angled, 5-pin(4+FE), L-coded, blue body, 50 V AC/60 V DC, 16 A; PUR grey cable, 1.50 mm²

Product Description

M12 Power Single-Ended Cordset: Male, angled, 5-pin(4+FE), L-coded, blue body, 50 V AC/60 V DC, 16 A; PUR grey cable, 1.50 mm²

Technical Drawing

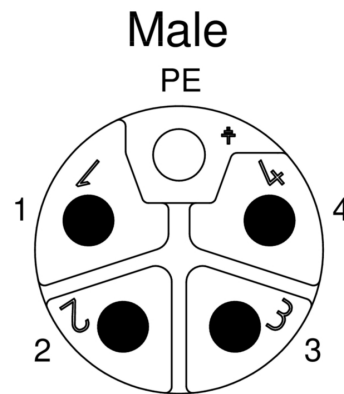
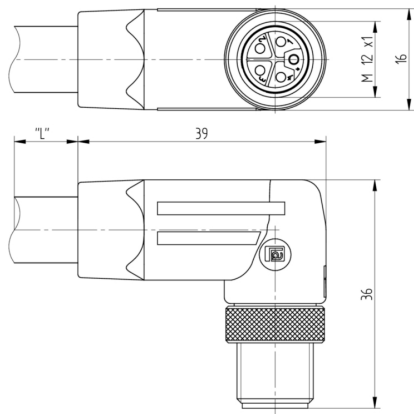

Technical Specifications

Face View

Pin 1	Pin 2	Pin 3	Pin 4	FE
brown	white	blue	black	pink

Technical Data

Product Family:	Power Connector
Product Sub Family:	M12 Power
Brand:	Lumberg Automation
Connector Type:	Cordset, single ended
Type of Contact / Gender:	male
Connector Design:	angled
Number of Pins:	5(4+FE)
Coding:	L
Shielding:	Unshielded
Attachment Type:	Coupling Screw
Rated Voltage:	63 V
Rated Voltage (UL):	63 V
Rated Impulse Voltage:	1.5 kV
Operating Voltage:	50 V AC / 60 V DC
Rated Current*:	16 A
Rated Current (UL)*:	16 A

Contact Resistance:	≤ 10 mOhm
Insulation Resistance:	> 10 ⁹ Ohm
Mating Cycles:	≤ 100
Ambient Temperature (Operation)*:	-40 °C to +125 °C, notice derating
Protection Degree / IP Rating**:	IP65, IP67, IP69K
Design Standard:	IEC 61076-2-111
Pollution Degree:	3 acc. to DIN EN 60664-1 (VDE 0110-1)
Clearance / Creepage Distance:	DIN EN 60664-1 (2008/01); VDE 0110-1
Overvoltage Category:	III acc. to DIN EN 60664-1 (VDE 0110-1)

Materials

Contact Base Material:	CuNi
Contact Plating:	Cu/Au
Contact Bearer Material:	PBT GF
Contact Bearer Color:	grey
Flammability Class (Contact Bearer):	UL 94 V-2
Molded Body Material:	TPE
Molded Body Color:	blue
Flammability Class (Molded Body):	UL 94 HB
Attachment Material:	CuZn
Attachment Plating:	Cu/Ni
O-Ring Material:	FKM

Additional Technical Data

Fastening Torque (Contact Screw):	M 12x1: (50-60) Ncm, hand-tight
-----------------------------------	---------------------------------

Cable Data

Cable Number:	949
Conductor Size:	1.50 mm ²
Number of Wires:	5
Minimal Bending Radius (Fixed Inst):	> 4 x D
Minimal Bending Radius (Flexible Inst):	> 7.5 x D
Cycles (Bending):	> 10 M
Conductor material:	Cu
Cable Jacket Material:	PUR
Cable Jacket Color:	grey (RAL 7032)
Cable Diameter D:	ø 8.0 ±0.20 mm
Wire Insulation Material:	PP
Insulated Wire Diameter:	ø 2.35 mm
Ambient Temperature (Fixed Installation):	-40 °C to +90 °C (UL AWM 80°C)
Ambient Temperature (Flex Installation):	-30 °C to +90 °C (UL AWM 80°C)
Ambient Temperature (Fixed Installation short-term 100h):	-40 °C to +125 °C
Ambient Temperature (Drag Chain Inst):	-20 °C to +60 °C
UL Cable Type:	AWM: 20939
Flammability Class (Cable Jacket):	VDE 0482-332-1-2, DIN EN 60332-1-2 / IEC 60332-1 / UL VW-1, CSA FT1

Approvals

UL-File:	E497237
UL:	UL 2237; cULus

Safety & Environmental Compliance

RoHS Compliant:	yes
-----------------	-----

Resistances

Halogenfree:	DIN VDE 0472 T.815
Oil Resistance:	HD 22.10 Appendix A, DIN EN 60811-404

Notes

Note Derating:	* Notice derating
Protection Degree / IP Rating Note:	** only if mounted and locked in combination with Hirschmann / Lumberg Automation connector.

Variants

Item #	Item Description	Cable Length
934852075	RSWT 5L-949/2 M	2 m
934852076	RSWT 5L-949/5 M	5 m
934852077	RSWT 5L-949/10 M	10 m
934852078	RSWT 5L-949/15 M	15 m

© 2020 Belden, Inc

All Rights Reserved.

Although Belden makes every reasonable effort to ensure their accuracy at the time of this publication, information and specifications described here in are subject to error or omission and to change without notice, and the listing of such information and specifications does not ensure product availability.

Belden provides the information and specifications herein on an "ASIS" basis, with no representations or warranties, whether express, statutory or implied. In no event will Belden be liable for any damages (including consequential, indirect, incidental, special, punitive, or exemplary damages) whatsoever, even if Belden has been advised of the possibility of such damages, whether in an action under contract, negligence or any other theory, arising out of or in connection with the use, or inability to use, the information or specifications described herein.

All sales of Belden products are subject to Belden's standard terms and conditions of sale.

Belden believes this product to be in compliance with all applicable environmental programs as listed in the data sheet. The information provided is correct to the best of Belden's knowledge, information and belief at the date of its publication. This information is designed only as a general guide for the safe handling, storage, and any other operation of the product itself or the one that it becomes a part of. The Product Disclosure is not to be considered a warranty or quality specification. Regulatory information is for guidance purposes only. Product users are responsible for determining the applicability of legislation and regulations based on their individual usage of the product.